

7900

ROMAN BLIND
SYSTEM

7900



G-RAIL[®]
ALUMINIUM RAIL

> *by Goelst*



Contained within the cassette headrail, the spiralled cord mechanisms provide smooth lifting of the chain operated Roman blind system. By adjusting the lifting cords, several decorative effects can be achieved.

Standard colour: White

7900 > The innov cassette Ro

ROMAN BLIND
SYSTEM

7900



Installation

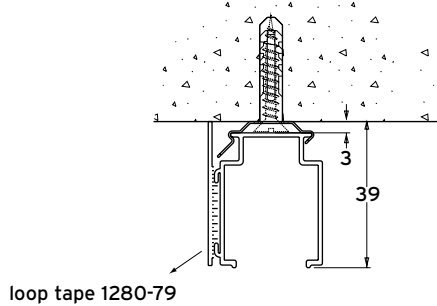

ceiling mounting with 7950

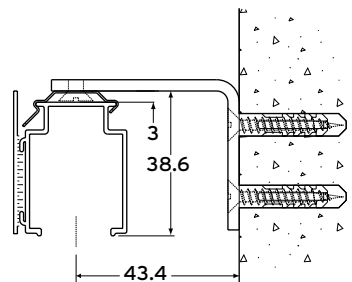

wall mounting with 2015-05

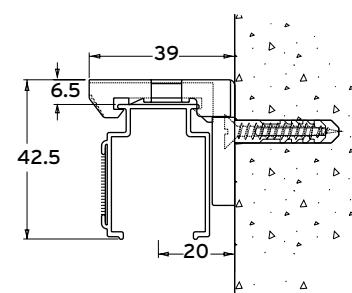

wall mounting with 7951-C

Curtain hanging examples

Roman Blind (soft fold)

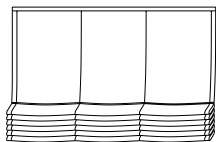

Roman Blind (hard fold)

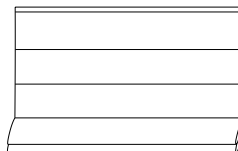

Greek Blind

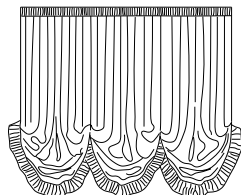

Austrian Blind

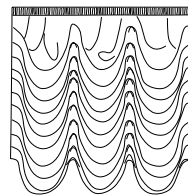

Festoon Blind

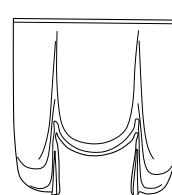

Belgian Blind

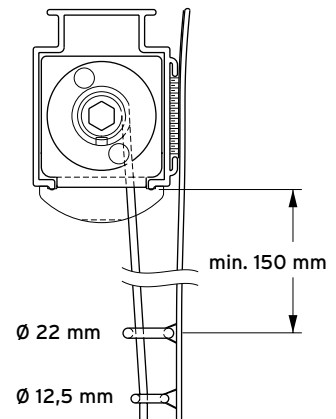

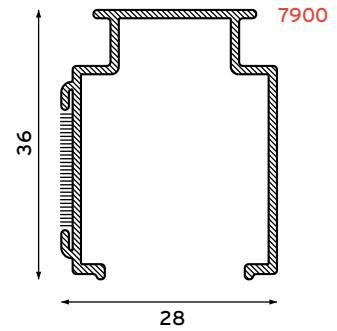

Specification Guide

Material:

U-form profile faced with Velcro. Aluminium 606035-T4-F13 (DIN 1725).

Shape and size tolerances are in accordance with DIN 17615. White powder coated finish. Rail weight 329 gr/m.

Accessories:

Variable profile connector 7952 and hexagonal drive connector 7925 for use in splay bays.

Installation:

Ceiling mounted with fixing clip 7950.

Wall / ceiling mounted with universal bracket 7951-C.





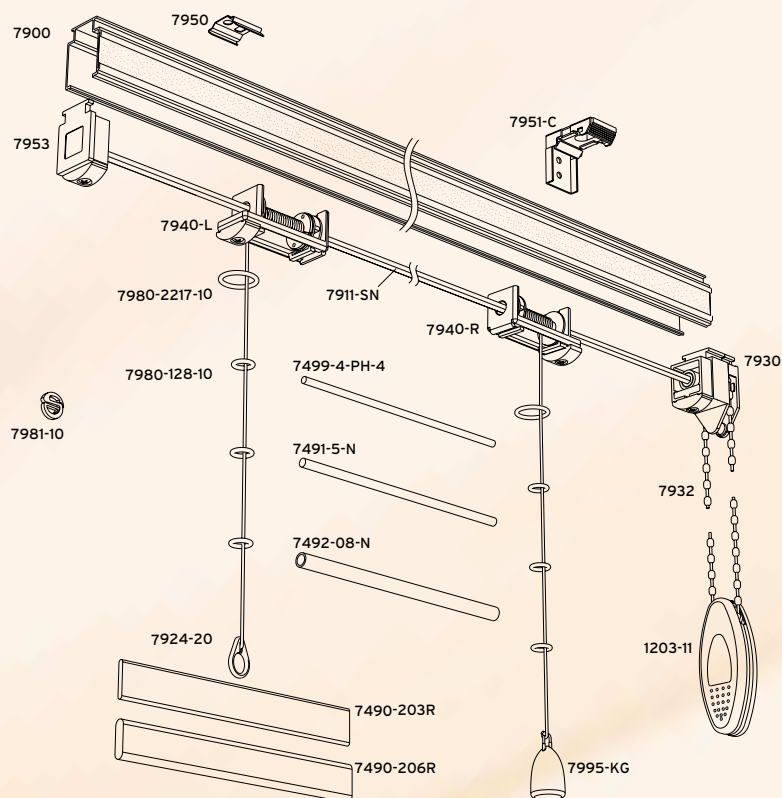



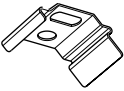
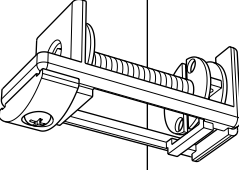
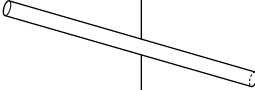
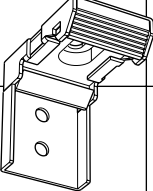
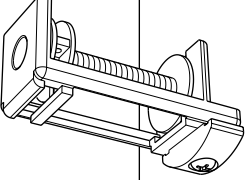
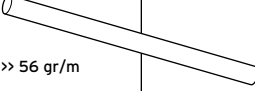
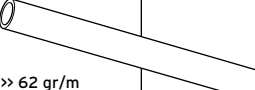
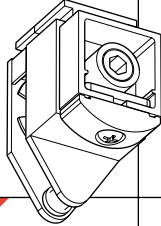
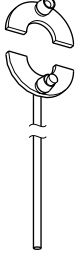
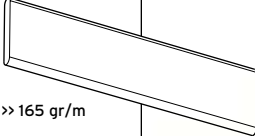
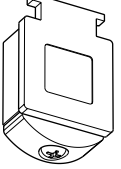
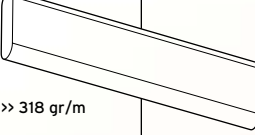
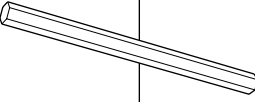

active man blind system.

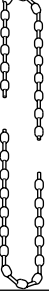
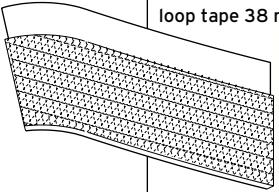
Exploded view

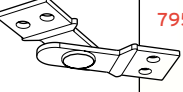

Components

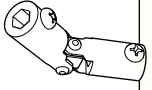
Product design and specification changes reserved.

FIXING BRACKETS					
	7950 ceiling bracket can be comb. with 2015 colours: N - W		7940-R winding spindle right hand (beige)		7499-4-PH-4 plexiglass insert 4 mm x 4 m
	7951-C wall / ceiling bracket		7940-L winding spindle left hand (black)		7491-5-N alum. round bar 5 mm x 6 m >> 56 gr/m
					7492-08-N alum. round tube 8 x 6 mm x 6 m >> 62 gr/m
ACCESSORIES					
	7930 chain control		7921-550-10 2x cord adapter (7922) + 1 mm cord 550 cm		7490-203R bottom bar 20 x 3 mm x 6 m colours: N - W >> 165 gr/m
	7953 end cap				7490-206R bottom bar 20 x 6 mm x 6 m colours: N - W >> 318 gr/m
			7911-SN-3.05 hexagonal drive shaft 3,05 m		7981-10 S-hook
	7932 endless chain 100 cm 150 cm 200 cm 250 cm 300 cm 400 cm		1280-79 loop tape 38 mm provides fabric upstand to ceiling level		7924-20 quick release cord ring (clear) for 1 mm cord
					7980-128-10 transparent ring 12,5 x 8 mm
	1203-11 chain weight		7952 adjustable profile connector		7980-2217-10 transparent ring 22 x 17 mm
			7925 universal connector		7995-KG Bell weight white

ROMAN BLIND SYSTEM

7900

N = natural
W = white

 = standard item

G-RAIL®

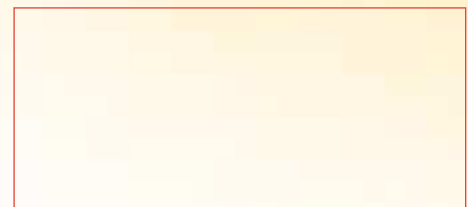
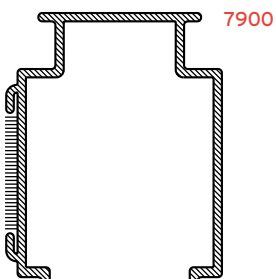

Space for dealer address

11/2002